

# MOUNTING INSTRUCTION

HYDROFLEX MINI LED  
CODES:401801-02-03

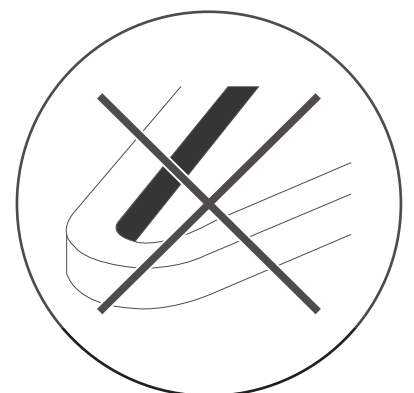

1. The most suitable operation temperature shall be  $-25^{\circ}\text{C}$  to  $50^{\circ}\text{C}$ .
2. Pls make sure that even during installation, the predetermined bending direction is NEVER changed. The product only have top bending, and can not be twisted.
3. HYDROFLEX MINI LED shall not be bent sharply. PC core and en-capsulation can not prevent any damage
4. The maximum bending diameter is 150mm, over bending will damage and void any warranty.
5. During the installation, the HYDROFLEX MINI LED can not be:
  - Twisted
  - Dropped
  - Bent at a  $90^{\circ}$  angle or bent at all
  - Sagging/Hanging down
6. Do not leave it together with card or paper directly as it will influence the surface clean.
7. For installation, 3 ways for your selection.
  - Mounting clips
  - Alumium profile
  - 3M tape
8. For the cutting unit, it is 50mm for white color and 83.33mm for RGB.

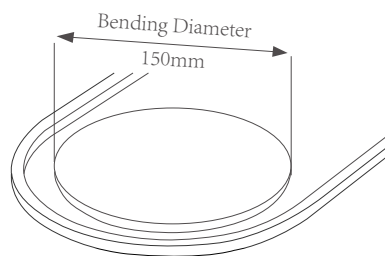
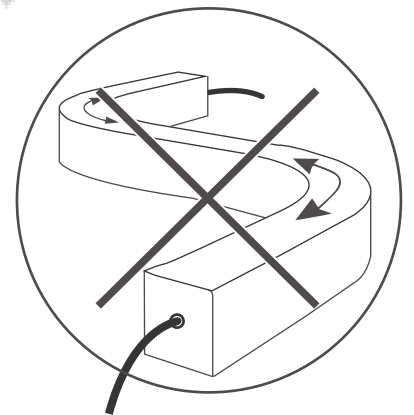
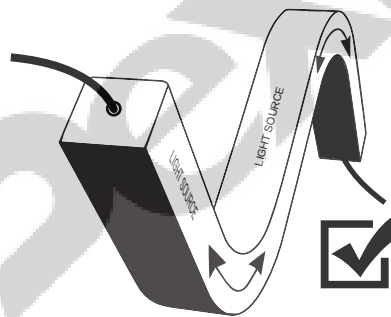
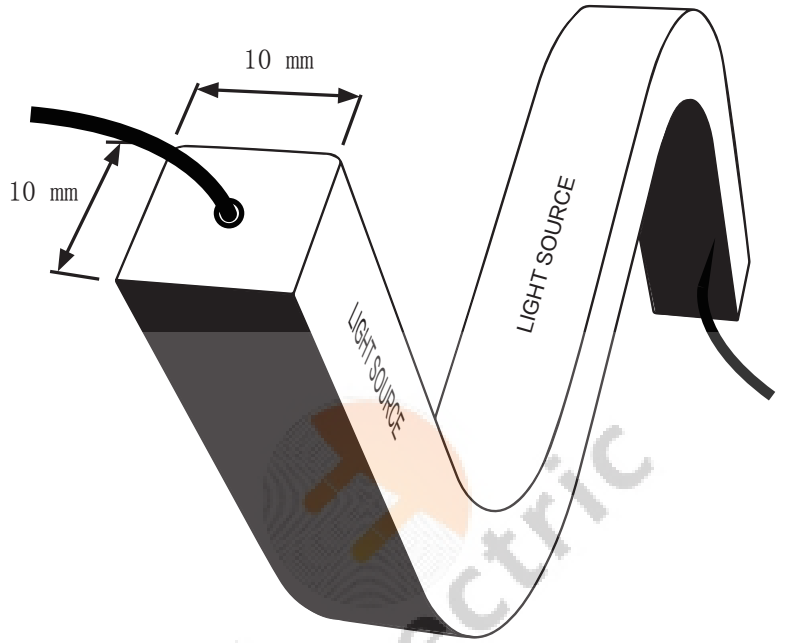

## STANDARD DIMENSION

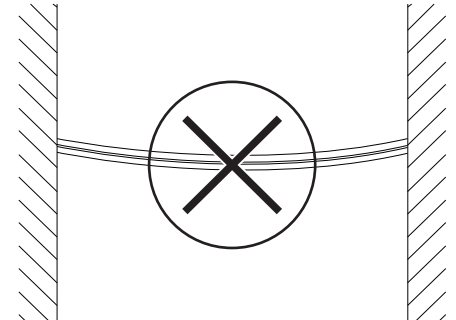
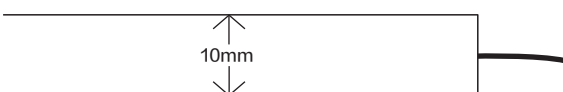
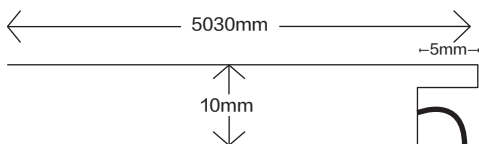

Do not twist

Do not hang

Do not droop

