

# HYDROTECH MEDIUM SQUARE LED

COD. 401006

COD. 401018

COD. 401014

COD.401019

## ASSEMBLY AND OPERATING INSTRUCTIONS:



--Class I fitting electric grounding is needed

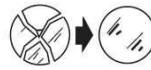

-replace the damaged protective glass

-glass features: plane float glass - safety tempered



-getting rid of as urban waste forbidden  
-separate collection is mandatory when the product is at the end of its life

**IP65**

-Complete protection from dust and water jets



Made in Italy **IK 07**



**GB** Retain the instructions.  
**I** Conservare le istruzioni.  
**D** Retain the instructions.  
**F** Bewahren Sie die Anleitung.  
**E** Conservez ces instructions.

**NB:** These assembly instructions must be given to end users for correct maintenance and so that they know how to change the bulb. The appliance must not be tampered with or transformed and it must be installed and used as supplied and in compliance with the National Rules on Installations. Any non-compliant installations will invalidate all forms of guarantee. The company cannot be held responsible for damage caused by incorrect assembly.

**COD. 401006**



MOVABLE

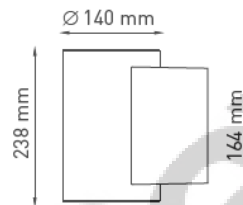
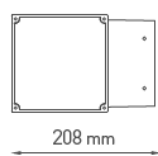

### HYDROTECH MEDIUM O2 SQUARE LED

- Power consumption : 2X8W
- Voltage :220-240V 50-60Hz
- Color Temperature : 3000K or 4000K
- Lens Type : 10° 30° 45°
- Insulation class: I
- IP protection: IP65
- Gross weight: 3kg

**COD. 401018**

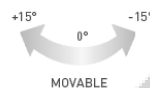

MOVABLE

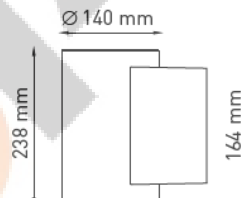
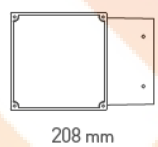

### HYDROTECH MEDIUM O2 SQUARE PRO LED

- Power consumption : 2X14W
- Voltage :220-240V 50-60Hz
- Color Temperature : 3000K
- Lens Type : 10° 30° 45°
- Insulation class: I
- IP protection: IP65
- Gross weight: 3kg

**COD. 401014**

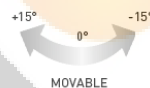

MOVABLE

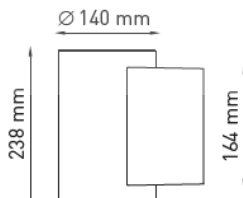
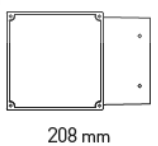

### HYDROTECH MEDIUM O1 SQUARE LED

- Power consumption : 8W
- Voltage :220-240V 50-60Hz
- Color Temperature : 3000K or 4000K
- Lens Type : 10° 30° 45°
- Insulation class: I
- IP protection: IP65
- Gross weight: 3kg

**COD. 401019**

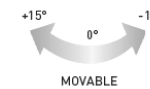

MOVABLE

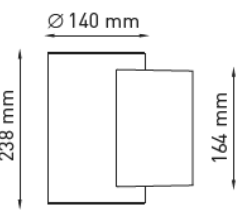
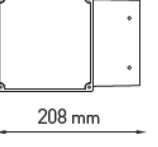

### HYDROTECH MEDIUM O1 SQUARE PRO LED

- Power consumption : 14W
- Voltage :220-240V 50-60Hz
- Color Temperature : 3000K
- Lens Type : 10° 30° 45°
- Insulation class: I
- IP protection: IP65
- Gross weight: 3kg

## Recommendations

- 1) verify that the equipment used to connect our devices to enjoy all the guarantees required under European law;
- 2) use the cables, connectors and quality materials for electrical wiring;
- 3) Products with IP65/68 degree make the wiring / connections with accessories provide the same degree IP of the selected product (available in the catalog);
- 4) In the case of installations outside is not recommended to install the power supplies in the formwork and / or in the junction box without adequate protection

## Choice of installation location

The unit should be positioned so that when in use is not subject to direct radiation from the sun or other heat sources . High temperatures reduce the life and efficiency of the components or the LED module .

## Relamping and maintenance:

-The relamping must be done with maximum attention avoiding to dirty the sealing gasket and its contact surface. It is therefore necessary before

opening the fixture to carefully wipe the floodlight then unscrew the round frame by the proper key

**-If the gasket is damaged, deformed or not in perfect conditions it is necessary to change it**

-it is essential to do a frequent cleaning of the glass and of the outer surface of the fixture to avoid build up of mud and dirtiness resulting in dangerous

overheating due to uncorrect light and heat dissipation. Clean carefully the glass screen removing limestone deposits by means of a scraper.

**.The replacement must be done by a qualified electrician.**

## INSTALLATION:

**-SWITCH-OFF THE POWER SUPPLY BEFORE CARRYING OUT ANY MAINTENANCE OPERATION**

- 1 Prepare holes in the wall using plugs type ficher (not included in the package), insert the cable through the rubber cable gland and then fix the plate
- 2 Tighten the plugs screws
- 3 Unscrew 2 screws of inner plate
- 4 Make the electrical connection to the terminal
- 5 refit the plate to the luminaire body (2 screws) and then place the luminaire to wall plate, fully tighten 4 grain screws

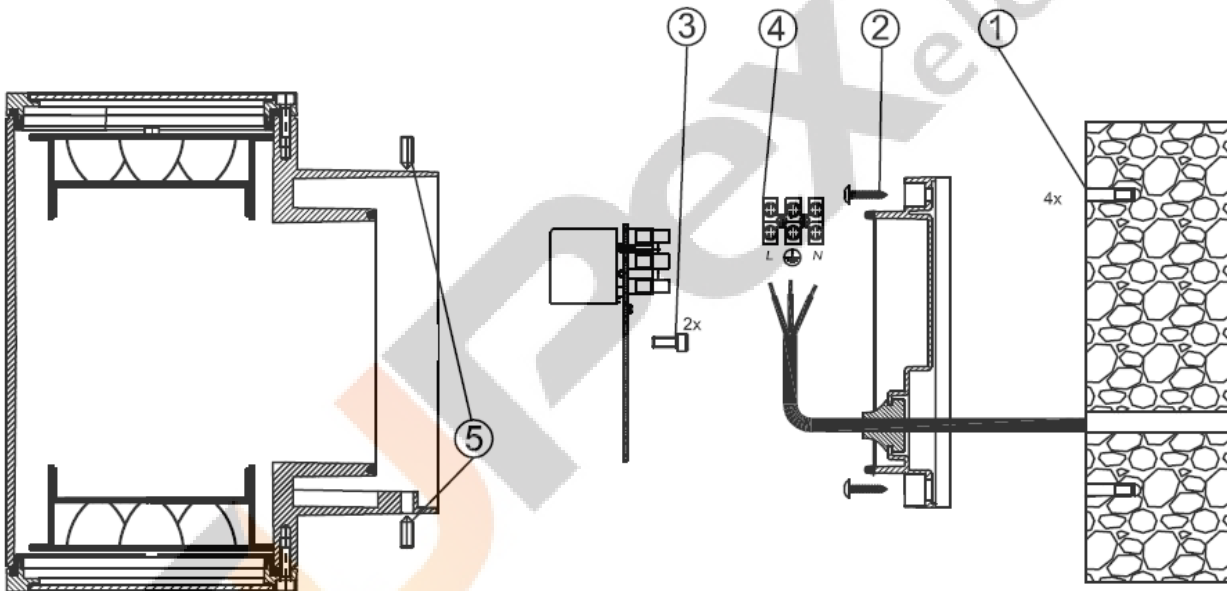

LAMP BASE FIXATION HOLES DIMENSIONS

