

HYDROFLOOR NANO XS

-COD. 201072

-COD. 709001

ASSEMBLY AND OPERATING INSTRUCTIONS:



protection class III
products that can only be operated with protected extra-low voltage



Made in Italy

IP68

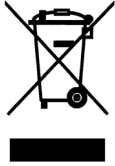

Directive 2002/96/CE (Waste Electrical and Electronic Equipment– WEEE)

Information for users:

The crossed out wheeled bin label that can be found on your product indicates that this product should not be disposed of via the normal household waste stream. To prevent possible harm to the environment or human health please separate this product from other waste streams to ensure that it can be recycled in an environmentally sound manner. For more details on available collection facilities please contact your local government office or the retailer where you purchased this product.

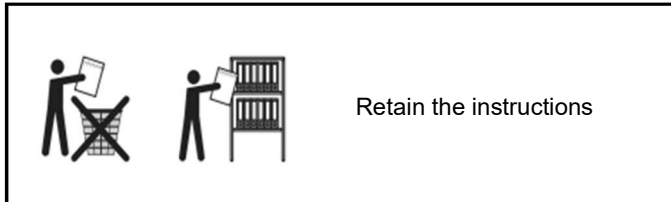

Retain the instructions

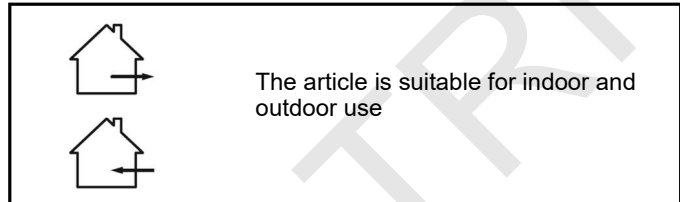

The article is suitable for indoor and outdoor use

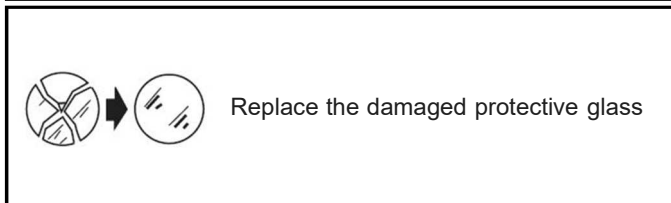

Replace the damaged protective glass

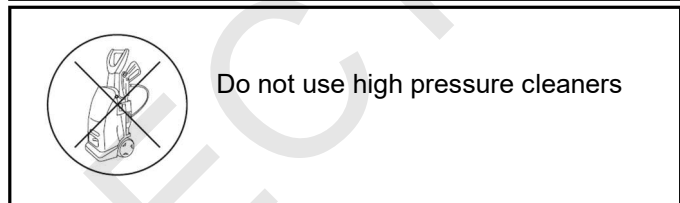

Do not use high pressure cleaners

- LED modules contained in this luminaire must be replaced by the manufacturer. For informations contact your supplier.
- If the external cable is damaged can be replaced only by the manufacturer or equivalent qualified personnel.
- Is forbidden to make any modification without authorization of the manufacturer. The safety of the fitting is guaranteed by respecting the electrical European norms.
- Installation must be carried out by a qualified personnel.
- Disconnect main power before maintenance operations.

COD. 201702

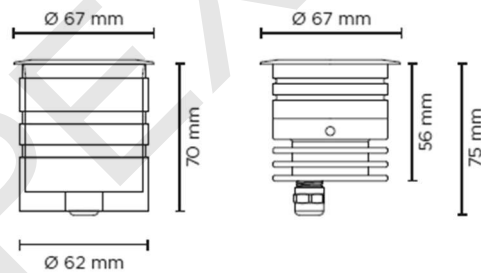
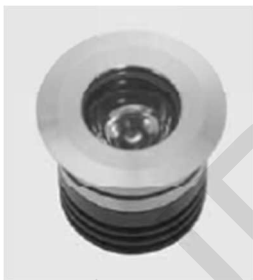

HYDROFLOOR NANO XS

- Power consumption : 2.5W @ 700mA
- Max Current: 700mA
- Color Temperature : 3000K - 4000K
- Beam angle : 10°-30°-45°
- Insulation class: III
- IK rating : IK09
- IP protection: IP68
- Gross weight: 0.7kg

COD. 709001

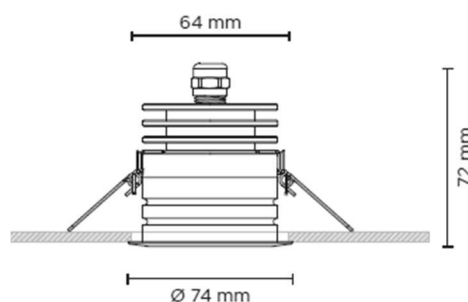

HYDROFLOOR NANO XS DOWNLIGHT

- Power consumption : 2.5W @ 700mA
- Max Current: 700mA
- Color Temperature : 3000K - 4000K
- Beam angle : 10°-30°-45°
- Insulation class: III
- IK rating : IK09
- IP protection: IP68
- Gross weight: 0.6kg

Recommendations

- Verify that the equipment used to connect our devices to enjoy all the guarantees required under European law;
- Use the cables, connectors and quality materials for electrical wiring;
- Products with IP68 degree make the wiring / connections with accessories provide the same degree IP of the selected product (available in the catalog);
- In the case of installations outside is not recommended to install the power supplies in the formwork and / or in the junction box without adequate protection

A scheduled maintenance programme must be carried out on the installation and the fittings regardless of their IP rating or application – these must include the following operations:

- Clean the fittings from dirt that may be deposited on the protection grills and in the heads of the screws by following the installation instructions attached to each fitting.
 - Check that the screws are not loose on the various components of the luminaire (glass frame, cable entry , ...).
 - Check each cable gland, and cable for damage and that the cable gland has not come loose.
 - For each Isolation Class 1 fitting check that the earth cable has not come loose. The clip must not show signs of oxidation, damage or become loose.
 - Check that all the seals are in good condition and that they are not dry, damaged or split.
 - Check the glass or plastic screen for damage and replace if required.
 - Check for water inside the luminaire's housing and its recessing box.
 - The internal components such as the ballasts, transformers, washers and screws must not show clear signs of oxidation or rust. Clear traces of rust and oxidation will indicate the presence of water inside the luminaire.
 - In case of damage the components must be replaced by original components and spare parts before using the fitting.
- We also recommend to check the fitting each time the lamp is replaced or at least once a year or within the prescribed maintenance schedule period depending on the type of installation.

Note on corrosion protection

For installation and maintenance be especially careful not to damage the coating powder . Damage combined action of water could cause corrosion.

- In the case of damage to the external flexible cable, it must be replaced by the manufacturer, or its assistance service, or equivalent qualified personnel in order to avoid dangers
- In the case of glass breakage, contact the device manufacturer to replace it. Replace the screen with an original replacement

Installation cod 201702 pic. 1

1. place the formwork 70mm from floor level
2. Make the adequate connection to the driver respecting the polarity
3. Push the fitting into the formwork

Installation cod 79001 pic.2

1. Prepare hole for recessing diam 64mm into the false ceiling
2. Make the adequate connection to the driver respecting the polarity
3. Turn the recessing springs upward and insert the fitting into the ceiling.

