

HYDROLINE STEP 01 02 LED

COD 503001

COD 503002

ASSEMBLY AND OPERATING INSTRUCTIONS:



-Apparecchio in classe I è necessario eseguire un collegamento con messa a terra

-Class I fitting electric grounding is needed

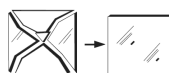

- replace the damaged protective glass
- sostituire i vetri di protezione se danneggiati
- die Beschädigten Schutzgläser ersetzen
- remplacer les verres de protection abimés
- glass features: plane float glass - safety tempered
- caratteristiche vetro: vetro piano float di sicurezza temperato
- Glaseigenschaften: Float-Flachglas, gehärtetes Sicherheitsglas
- caractéristiques du verre: type de verre: plan "float" de sûreté trempé



- getting rid of as urban waste forbidden
- separate collection is mandatory when the product is at the end of its life

-è vietato lo smaltimento come rifiuto urbano
-è obbligatoria la raccolta separata a fine vita del prodotto

-Das Entsorgen im Hausmüll ist verboten!
-Bei Ablauf der Lebensdauer bitte beachten:
-Abfalltrennung ist Pflicht

-il est interdit l'élimination comme ordure urbaine
-le ramassage séparé est obligatoire lorsque le produit est à la fin de sa vie

CE Made in Italy **IP67**

NB: These assembly instructions must be given to end users for correct maintenance and so that they know how to change the bulb. The appliance must not be tampered with or transformed and it must be installed and used as supplied and in compliance with the National Rules on Installations. Any non-compliant installations will invalidate all forms of guarantee. The company cannot be held responsible for damage caused by incorrect assembly.



- GB Retain the instructions.
- I Conservare le istruzioni.
- D Retain the instructions.
- F Bewahren Sie die Anleitung.
- E Conservez ces instructions.

COD. 503001

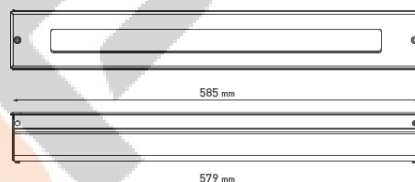
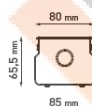

HYDROLINE STEP 01 LED

- Power consumption : 17W
- Voltage : 220-240V 50-60Hz
- Color Temperature : 3000K
- Beam angle : ASYM 120°
- Insulation class: I
- IP protection: IP67
- Gross weight: 4kg

COD. 503002

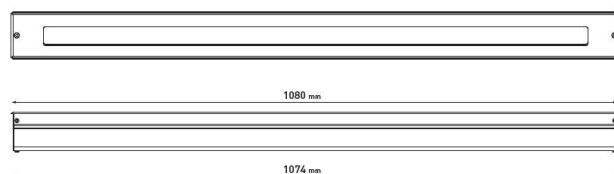
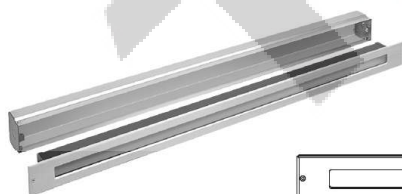

HYDROLINE STEP 02 LED

- Power consumption : 34W
- Voltage : 220-240V 50-60Hz
- Color Temperature : 3000K – 4000K
- Beam angle : ASYM 120°
- Insulation class: I
- IP protection: IP67
- Gross weight: 7kg



OK



NO!

Use only supply cables with double case

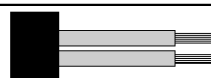

H07RN-F
1,5 mm²

Use only <HAR> flexible cables of suitable diameter. DO NOT USE HARD CABLES OR ARMORED CABLE (hard cable could effect the IP67 protection)



Do not use water high pressure cleaners

Recommendations

- 1) verify that the equipment used to connect our devices to enjoy all the guarantees required under European law;
- 2) use the cables, connectors and quality materials for electrical wiring;
- 3) Products with IP65/68 degree make the wiring / connections with accessories provide the same degree IP of the selected product (available in the catalog);
- 4) In the case of installations outside is not recommended to install the power supplies in the formwork and / or in the junction box without adequate protection

Choice of installation location

The unit should be positioned so that when in use is not subject to direct radiation from the sun or other heat sources . High temperatures reduce the life and efficiency of the components or the LED module .

HYDROLINE STEP INSTALLATION

The luminaire is supplied by us with LED illuminator already installed with built in power supply -it is essential to do a frequent cleaning of the glass and of the outer surface of the fixture to avoid build up of mud and dirtiness resulting in dangerous overheating due to uncorrect light and heat dissipation. Clean carefully the glass screen removing limestone deposits by means of a scraper.

-SWITCH-OFF THE POWER SUPPLY BEFORE CARRYING OUT ANY MAINTENANCE OPERATIONS

The floodlight is supplied by us with the led pre-installed and connected with 1 meter cable
The cable and the fixture must not be tampered with for any reason.

Relamping and maintenance:

- It is necessary before opening the fixture to carefully wipe the floodlight then unscrew the side covers by the proper key
- If the gasket is damaged, deformed or not in perfect conditions it is necessary to change it

Installation:

1. Remove the luminaire from the steel formwork
2. Install the formwork trimmed to the wall and positioning the corrugated pipe in the hole of the formwork. (pic2)
3. Make the correct electrical connection with the line, using a proper cable connector IP67 degree. (see catalog for more informations)
3. Place the luminaire into the formwork and tighten 2 screws provided pic.2

1

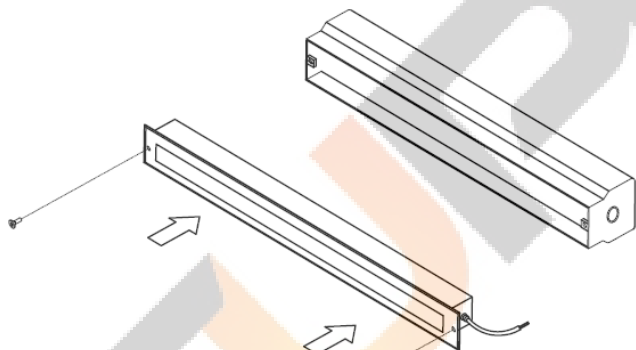

2

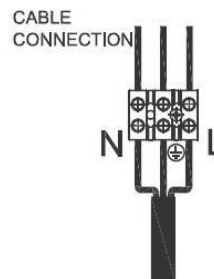

3

