



807001 - 807004

## RING POLE MINI

Designed by  
NAVA + AROSIO

Floodlight for outdoor installation on a pole diam. 60 mm or 76 mm, with 355° swivel pole attachment and allowing horizontal adjustment of +90° / -40°. Phospho-chromatised and polyester powder coated die-cast copper-free aluminium base and head, tempered safety glass, moulded silicone gaskets and o-rings, with screws in stainless steel. Swivel pole joint with graduated scale and mechanical aiming lock. Built-in LED driver, with 1 COB CREE "CXB 1310" LED. IP66 rating.

807001

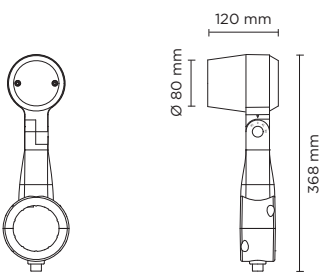

807004

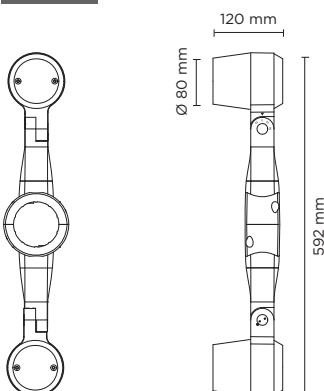

### Technical features



### Available on request



### Technical data



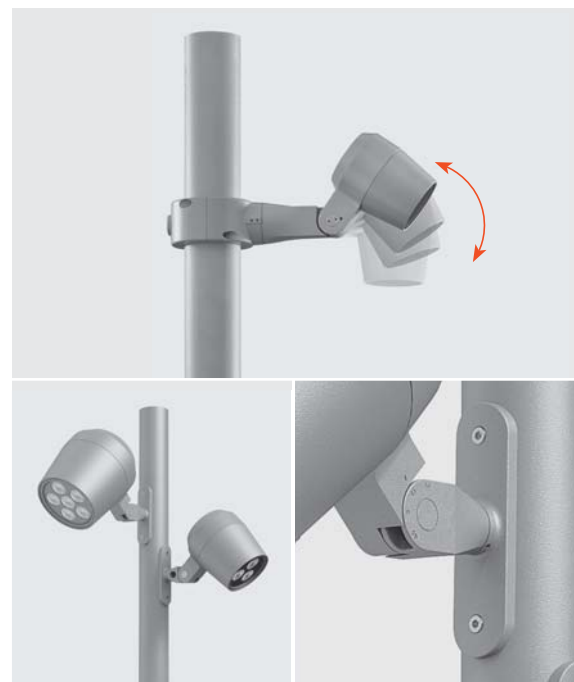



|             |  |
|-------------|--|
| IP Rating   | IP66   |
| IK Rating   | IK10   |
| Material    | High corrosion resistance die-cast copper-free aluminum body |
| Coating     | Polyester powder coating with phosphochromating pre-finish   |
| Screws      | Stainless steel  |
| Transformer | Electrical power supply 220/240V 50/60Hz built-in            |
| Gasket      | Silicone rubber  |
| Glass       | Tempered   |
| Cable gland | M16 rubber grommet   |
| Power cable | 3 Mt. Power cable included                                   |



### NEW AESTHETIC POLE ATTACHMENT AVAILABLE ON REQUEST

#### AC085 - POLE PLATE

Pole plate for pole mounting of all Ring models, suitable to be used with poles diam. min 76 mm and diam. max 120 mm. Can be positioned on various staggered levels or on a single level, with the same pole. Made in phospho-chromatised and polyester powder coated die-cast copper-free aluminum material, moulded silicone gaskets and screws in stainless steel.

| 807001                                 |   | SINGLE RING POLE MINI - 10 WATT 220-240V 50-60HZ |                        |  |
|--|---|--|------------------------|--|
| light source                           | light beam options  | lumen output (lm)                                | lumin. efficacy (lm/w) |  |
| <b>3000°K warm-white</b>               |   |  |                        |  |
| cob led                                |  14° | 1.100  | 110                    |  |
| cob led                                |  35° | 1.060  | 106                    |  |
| cob led                                |  55° | 1.000  | 100                    |  |
| <b>4000°K neutral-white</b>            |   |  |                        |  |
| cob led                                |  14° | 1.200  | 120                    |  |
| cob led                                |  35° | 1.140  | 114                    |  |
| cob led                                |  55° | 1.083  | 108                    |  |
| <b>2700°K CCT</b> available on request |   |  |                        |  |







#### Colors options

-  Textured Grey RAL 9006
-  Anthracite Grey RAL 7016
-  Matt Black (on request)

#### Technical data

|              |                           |
|--------------|---------------------------|
| Wattage      | 10 WATT                   |
| Light source | 1 COB CREE "CXB 1310" LED |
| Gross weight | 2,00 Kg                   |



| 807004                                 |   | DOUBLE RING POLE MINI - 2X10 WATT 220-240V 50-60HZ |                        |  |
|--|---|--|------------------------|--|
| light source                           | light beam options  | lumen output (lm)                                  | lumin. efficacy (lm/w) |  |
| <b>3000°K warm-white</b>               |   |  |                        |  |
| cob led                                |  14° | 2 x 1.100  | 110                    |  |
| cob led                                |  35° | 2 x 1.060  | 106                    |  |
| cob led                                |  55° | 2 x 1.000  | 100                    |  |
| <b>4000°K neutral-white</b>            |   |  |                        |  |
| cob led                                |  14° | 2 x 1.200  | 120                    |  |
| cob led                                |  35° | 2 x 1.140  | 114                    |  |
| cob led                                |  55° | 2 x 1.083  | 108                    |  |
| <b>2700°K CCT</b> available on request |   |  |                        |  |

#### Colors options

-  Textured Grey RAL 9006
-  Anthracite Grey RAL 7016
-  Matt Black (on request)

#### Technical data

|              |                           |
|--------------|---------------------------|
| Wattage      | 2X10 WATT                 |
| Light source | 2 COB CREE "CXB 1310" LED |
| Gross weight | 3,50 Kg                   |



## POLES & ACCESSORIES

Full technical details of poles and accessories for poles are available at the end of the catalogue

| BURIED POLES |                    |
|--------------|--------------------|
| code         | h. mm.             |
| 809901       | 3.500              |
| 809902       | 4.500              |
| 809903       | 5.500              |
| 809909       | TOP CAP DIAM 76mm. |

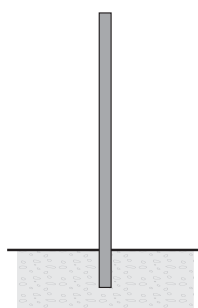

| POLES WITH BASE-PLATE |                   |
|-----------------------|-------------------|
| code                  | h. mm.            |
| 809904                | 3.000             |
| 809905                | 4.000             |
| 809906                | 5.000             |
| 809907                | ACC.              |
| 809909                | TOP CAP DIAM 76mm |

