



807002 - 807005

RING POLE MEDIUM

Designed by
NAVA + AROSIO

Floodlight for outdoor installation on a pole diam. 60 mm or 76 mm, with 355° swivel pole attachment and allowing horizontal adjustment of +90° / -40°. Phosphochromatised and polyester powder coated die-cast copper-free aluminium base and head, tempered safety glass, moulded silicone gaskets and o-rings, with screws in stainless steel. Swivel pole joint with graduated scale and mechanical aiming lock. Built-in LED driver, with 1 COB CREE "CXB 1512" LED. IP66 rating.

807002

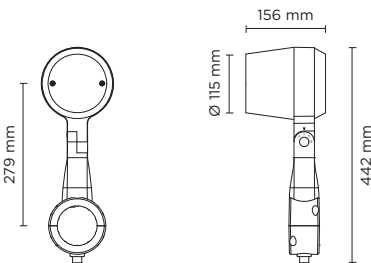

807005

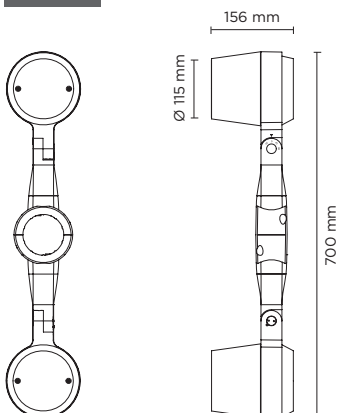

Technical features



Available on request



Technical data



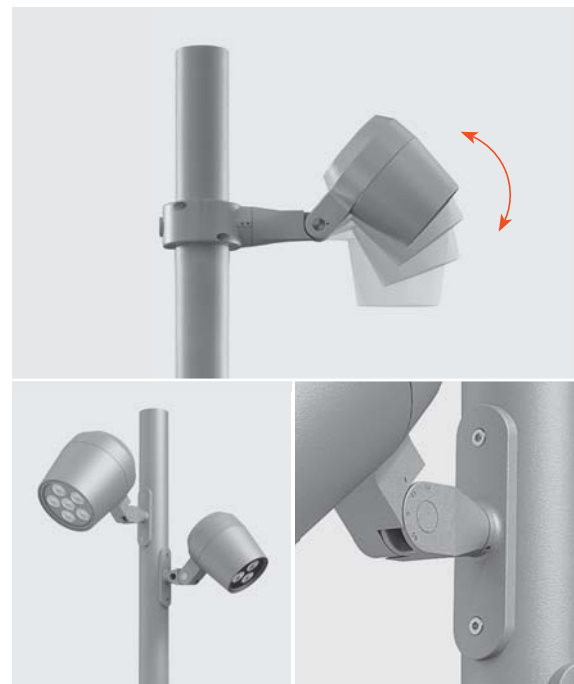



IP Rating	IP66
IK Rating	IK10
Material	High corrosion resistance die-cast copper-free aluminum body
Coating	Polyester powder coating with phosphochromating pre-finish
Screws	Stainless steel
Transformer	Electrical power supply 220/240V 50/60Hz built-in
Gasket	Silicone rubber
Glass	Tempered
Cable gland	M16 rubber grommet
Power cable	3 Mt. Power cable included



NEW AESTHETIC POLE ATTACHMENT AVAILABLE ON REQUEST

AC085 - POLE PLATE

Pole plate for pole mounting of all Ring models, suitable to be used with poles diam. min 76 mm and diam. max 120 mm. Can be positioned on various staggered levels or on a single level, with the same pole. Made in phosphochromatised and polyester powder coated die-cast copper-free aluminum material, moulded silicone gaskets and screws in stainless steel.

807002		SINGLE RING POLE MEDIUM - 16 WATT 220-240V 50-60HZ		
light source	light beam options	lumen output (lm)	lumin. efficacy (lm/w)	
3000°K warm-white				
cob led	 14°	1.900	118.75	
cob led	 35°	1.813	113.31	
cob led	 55°	1.722	107.62	
4000°K neutral-white				
cob led	 14°	2.000	125.00	
cob led	 35°	1.900	118.75	
cob led	 55°	1.805	112.81	







2700°K CCT available on request

Colors options

-  Textured Grey RAL 9006
-  Anthracite Grey RAL 7016
-  Matt Black (on request)

Technical data	
Wattage	16 WATT
Light source	1 COB CREE "CXB 1512" LED
Gross weight	3,00 Kg



807005		DOUBLE RING POLE MEDIUM - 2X16 WATT 220-240V 50-60HZ		
light source	light beam options	lumen output (lm)	lumin. efficacy (lm/w)	
3000°K warm-white				
cob led	 14°	2 x 1.900	118.75	
cob led	 35°	2 x 1.813	113.31	
cob led	 55°	2 x 1.722	107.62	
4000°K neutral-white				
cob led	 14°	2 x 2.000	125.00	
cob led	 35°	2 x 1.900	118.75	
cob led	 55°	2 x 1.805	112.81	

2700°K CCT available on request

Colors options

-  Textured Grey RAL 9006
-  Anthracite Grey RAL 7016
-  Matt Black (on request)

Technical data	
Wattage	2X16 WATT
Light source	2 COB CREE "CXB 1512" LED
Gross weight	5,50 Kg



POLES & ACCESSORIES

Full technical details of poles and accessories for poles are available at the end of the catalogue

BURIED POLES	
code	h. mm.
809901	3.500
809902	4.500
809903	5.500
809909	TOP CAP DIAM 76mm

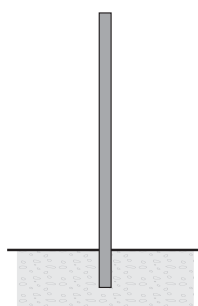

POLES WITH BASE-PLATE	
code	h. mm.
809904	3.000
809905	4.000
809906	5.000
809907	ACC.
809909	TOP CAP DIAM 76mm

