



807014 - 807016

RING POLE MEGA HP

Designed by
NAVA + AROSIO

Floodlight for outdoor installation on a pole diam. 60 mm or 76 mm, with 355° swivel pole attachment and allowing horizontal adjustment of +90° / -40°. Phospho-chromatised and polyester powder coated die-cast copper-free aluminium base and head, tempered safety glass, moulded silicone gaskets and o-rings, with screws in stainless steel. Swivel pole joint with graduated scale and mechanical aiming lock. Built-in LED driver, with 12 x CREE "XH-P 35" LED. IP66 rating.

807014	SINGLE RING POLE MEGA HP - 88 WATT 220-240V 50-60HZ			
light source	light beam options	lumen output (lm)	lumin. efficacy (lm/w)	
3000°K warm-white				
high-power led	4°	9.500	107.96	
high-power led	10°	9.450	107.38	
high-power led	28°	9.380	106.59	
4000°K neutral-white				
high-power led	4°	9.600	109.09	
high-power led	10°	9.550	108.52	
high-power led	28°	9.480	107.73	
2700°K CCT available on request				

Colors options

Textured Grey
RAL 9006

Anthracite Grey
RAL 7016

Matt Black
(on request)

Technical features



Available on request



Technical data

IP Rating	IP66
IK Rating	IK10
Material	High corrosion resistance die-cast copper-free aluminum body
Coating	Polyester powder coating with phosphochromating pre-finish
Screws	Stainless steel
Transformer	Power supply 220/240V 50/60Hz built-in
Gasket	Silicone rubber
Glass	Tempered
Cable gland	M16 rubber grommet
Power cable	3 mt. power cable included







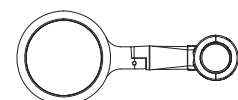
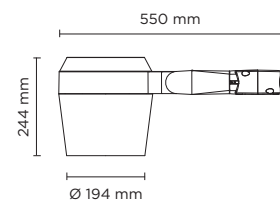

Technical data

Wattage	88 WATT
Light source	12 x CREE "XH-P 35" LED
Gross weight	8,50 Kg



807016

DOUBLE RING POLE MEGA HP - 2X88 WATT 220-240V 50-60HZ

light source	light beam options	lumen output (lm)	lumin. efficacy (lm/w)
3000°K warm-white			
high-power led	 4°	2x9.500	107.96
high-power led	 10°	2x9.450	107.38
high-power led	 28°	2x9.380	106.59
4000°K neutral-white			
high-power led	 4°	2x9.600	109.09
high-power led	 10°	2x9.550	108.52
high-power led	 28°	2x9.480	107.73
2700°K CCT available on request			

Colors options
 Textured Grey
RAL 9006

 Anthracite Grey
RAL 7016

 Matt Black
(on request)
Technical data

Wattage 2x88 WATT

Light source 24 x CREE
"XH-P 35" LED

Gross weight 16,50 Kg

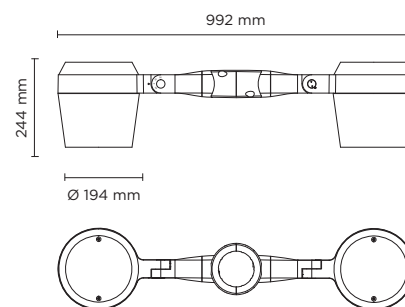
**DIFFERENT POSSIBILITIES AS MULTIPLE APPLICATION ON THE SAME POLE:**

LUMINAIRE SUITABLE FOR POLE MOUNTING
IN SINGLE OR MULTIPLE COMBINATIONS

AC085 - POLE PLATE

Pole plate for pole mounting of all Ring models, suitable to be used with poles diam. min 76 mm and diam. max 120 mm. Can be positioned on various staggered levels or on a single level, with the same pole. Made in phospho-chromatised and polyester powder coated dia-cast copper-free aluminum material, moulded silicone gaskets and screws in stainless steel.

AC089 - TREE-BRANCH BRACKET

Special bracket for Ring Mega pole mounting, suitable to be used with poles diam. min 76 mm and diam. max 120 mm. Can be positioned on various staggered levels or on a single level, with the same pole. Made in phospho-chromatised and polyester powder coated dia-cast copper-free aluminum material, moulded silicone gaskets and screws in stainless steel.

**SOME APPLICATION EXAMPLES:**

3 X RING MEGA
ON VARIOUS STAGGERED
LEVELS ON THE
SAME POLE

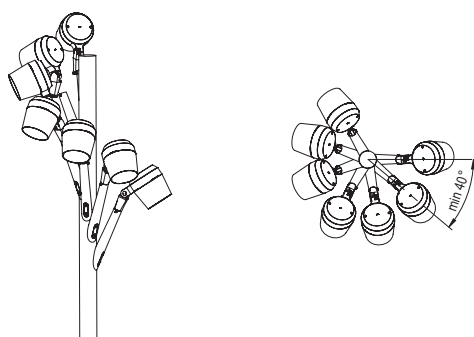

4 X RING MEGA
ON VARIOUS STAGGERED
LEVELS ON THE
SAME POLE

**On various staggered levels**Min. angle between luminaire heads **40°****On a single level**Min. angle between luminaire heads **80°**