

# QUBO POLE MEDIUM MAXI

-COD. 808001

-COD. 808002

## ASSEMBLY AND OPERATING INSTRUCTIONS:

-COD. 808003

-COD. 808004







-Class I fitting electric grounding is needed



Directive 2002/96/CE (Waste Electrical and Electronic Equipment– WEEE)

Information for users:

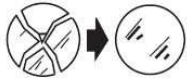
The crossed out wheeled bin label that can be found on your product indicates that this product should not be disposed of via the normal household waste stream. To prevent possible harm to the environment or human health please separate this product from other waste streams to ensure that it can be recycled in an environmentally sound manner. For more details on available collection facilities please contact your local government office or the retailer where you purchased this product.

 <p>Retain the instructions</p>	 <p>The article is suitable for indoor and outdoor use</p>
 <p>Replace the damaged protective glass</p>	 <p>Do not use high pressure cleaners</p>

NB: These assembly instructions must be given to end users for correct maintenance and so that they know how to change the bulb. The appliance must not be tampered with or transformed and it must be installed and used as supplied and in compliance with the National Rules on Installations. Any non-compliant installations will invalidate all forms of guarantee. The company cannot be held

### COD. 801001

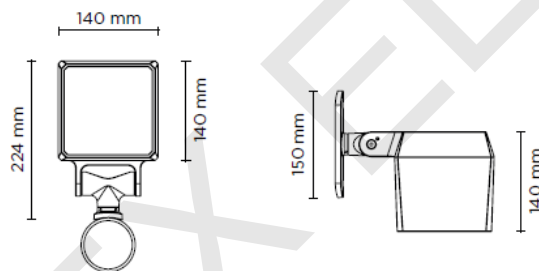

#### QUBO MEDIUM COB POLE

- Power consumption : 16W
- Voltage : 220-240V 50-60Hz
- Color Temperature : 3000K - 4000K
- Beam angle : 14°-35°-55°
- Insulation class: I
- IK rating : IK10
- IP protection: IP66
- Gross weight: 3.1kg

### COD. 808002

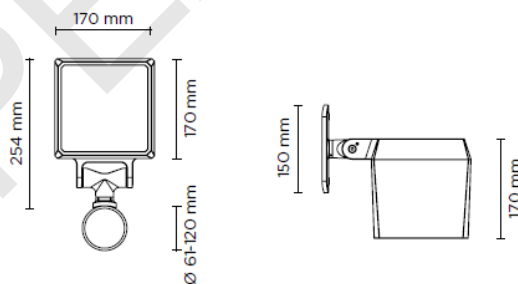

#### QUBO MAXI COB POLE

- Power consumption : 42W
- Voltage : 220-240V 50-60Hz
- Color Temperature : 3000K - 4000K
- Beam angle : 14°-35°-55°
- Insulation class: I
- IK rating : IK10
- IP protection: IP66
- Gross weight: 4.5kg

### COD. 808003

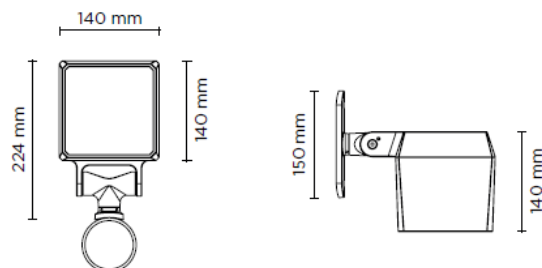

#### QUBO MEDIUM HP POLE

- Power consumption : 20W
- Voltage : 220-240V 50-60Hz
- Color Temperature : 3000K - 4000K
- Beam angle : 4°-10°-28°
- Insulation class: I
- IK rating : IK10
- IP protection: IP66
- Gross weight: 3.1kg

**COD. 808004**

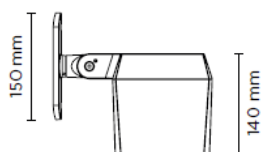
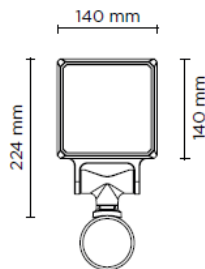

**QUBO MAXI HP POLE**

- Power consumption : 38W
- Voltage : 220-240V 50-60Hz
- Color Temperature : 3000K - 4000K
- Beam angle : 4°-10°-28°
- Insulation class: I
- IK rating : IK10
- IP protection: IP66
- Gross weight: 4.5kg

**Recommendations**

- Verify that the equipment used to connect our devices to enjoy all the guarantees required under European law;
- Use the cables, connectors and quality materials for electrical wiring;
- Products with IP66 degree make the wiring / connections with accessories provide the same degree IP of the selected product (available in the catalog);
- In the case of installations outside is not recommended to install the power supplies in the formwork and / or in the junction box without adequate protection

A scheduled maintenance programme must be carried out on the installation and the fittings regardless of their IP rating or application – these must include the following operations:

- Clean the fittings from dirt that may be deposited on the protection grills and in the heads of the screws by following the installation instructions attached to each fitting.
  - Check that the screws are not loose on the various components of the luminaire (glass frame, cable entry , ...).
  - Check each cable gland, and cable for damage and that the cable gland has not come loose.
  - For each Isolation Class 1 fitting check that the earth cable has not come loose. The clip must not show signs of oxidation, damage or become loose.
  - Check that all the seals are in good condition and that they are not dry, damaged or split.
  - Check the glass or plastic screen for damage and replace if required.
  - Check for water inside the luminaire's housing and its recessing box.
  - The internal components such as the ballasts, transformers, washers and screws must not show clear signs of oxidation or rust. Clear traces of rust and oxidation will indicate the presence of water inside the luminaire.
  - In case of damage the components must be replaced by original components and spare parts before using the fitting.
- We also recommend to check the fitting each time the lamp is replaced or at least once a year or within the prescribed maintenance schedule period depending on the type of installation.
- Terminal block not included. Installation may require advice from a qualified person. For wiring use a terminal complies with EN60998-2-1, EN 60998-2-2. The IP rating of the electrical connection must be equal to or greater than the IP rating of the luminaire.

**Note on corrosion protection**

- For installation and maintenance be especially careful not to damage the coating powder . Damage combined action of water could cause corrosion.
- In the case of damage to the external flexible cable, it must be replaced by the manufacturer, or its assistance service, or equivalent qualified personnel in order to avoid dangers
  - In the case of glass breakage, contact the device manufacturer to replace it. Replace the screen with an original replacement

**Installation:**

- Prepare holes in the pole in the desired position making two M5 threads and one central hole used to pass through the cables and connectors(pic. 1)
- Place the pole plate gasket and make the electrical connection following the correct safety electrical rules. (pic. 2)
- Fix the the luminaire to the pole tightening the two fixing screws (pic. 3)
- Adjust the desired angle of the luminaire unscrewing and then tightening the two screws and the grub screws of the luminaire joint using the tools included in the package. (pic.4)

①

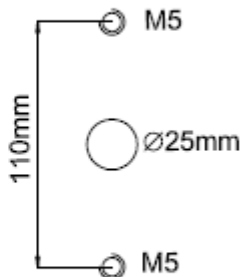

②

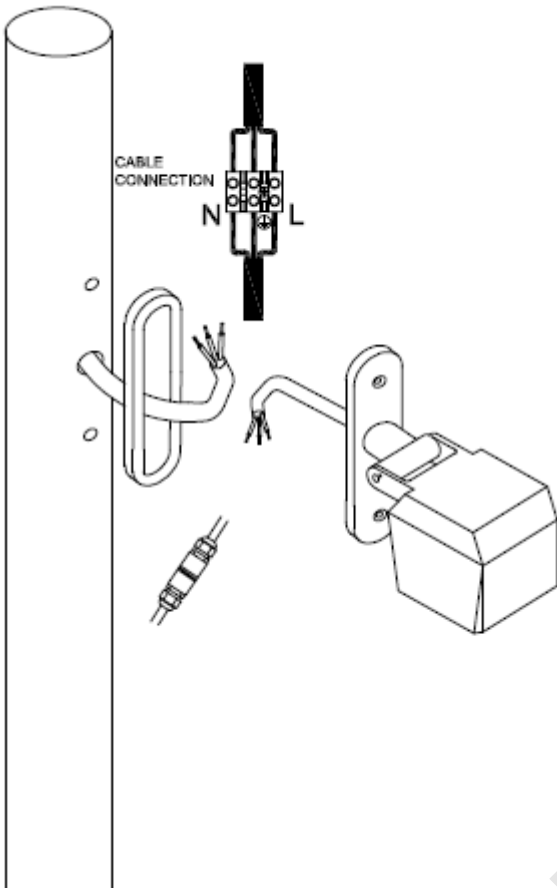

③

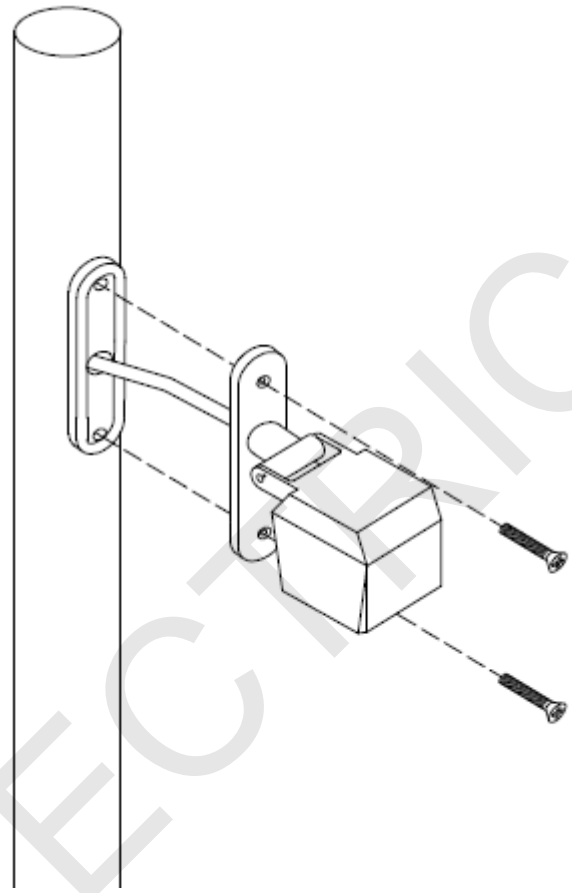

④

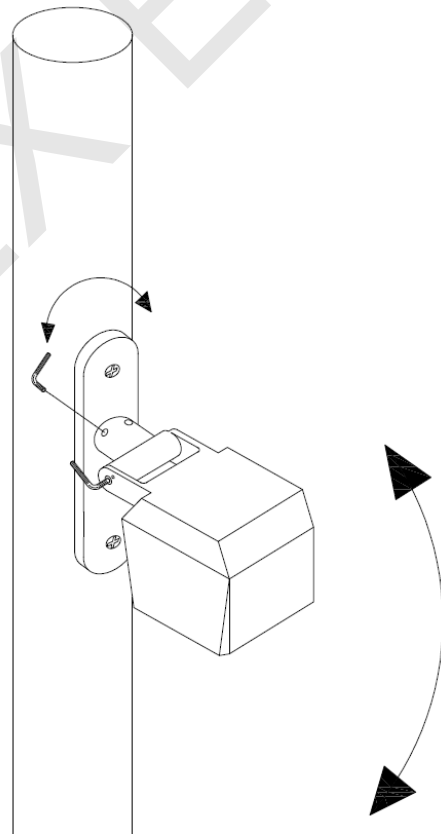

BURIED POLES	
code	h. mm.
809901	3.500
809902	4.500
809903	5.500
809909	TOP CAP DIAM 76mm.

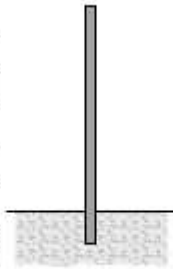

POLES WITH BASE-PLATE	
code	h. mm.
809904	3.000
809905	4.000
809906	5.000
809907	ACC.
809909	TOP CAP DIAM 76mm

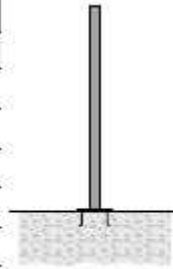

## CLASS I

L	Life / Linea / Leitung Ligne / Linea / Fas Fase / Фаза / Vaihe Linha	Brown / Marrone / Braun Brun / Marrón / Brun Bruin / коричневый / Muskea Marrom
N	Neutral / Neutro / Null Neutre / Neutro / Nolla Nul / Ноль / Nolla Neutro	Blue / Blu / Blau Bleu / Azul / Blå Blauw / синий / Sininen Azul
	Earth / Terra / Erde Terre / Tierra / Jord Aarde / Земля / Suojamaa Terra	Yellow-Green / Giallo-Verde / Gelb-Grün Jaune-Vert / Amarillo-Verde / Gul-Grön Geel-Groen / Желто-зеленый Keltainen-Vihreä / Amarelo-Verde



See the connector accessory instruction

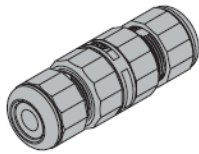

## RAEE - WEEE

- GB** Directive 2002/96/CE (Waste Electrical and Electronic Equipment - WEEE): information for users  
The crossed out wheeled bin label that can be found on your product indicates that this product should not be disposed of via the normal household waste stream. To prevent possible harm to the environment or human health please separate this product from other waste streams to ensure that it can be recycled in an environmentally sound manner. For more details on available collection facilities please contact your local government office or the retailer where you purchased this product.
- I** DIRETTIVA 2002/96/CE (Rifiuti di Apparecchiature Elettriche ed Elettroniche - RAEE): informazioni agli utenti  
L'etichetta con il cassonetto barrato presente sul prodotto indica che il prodotto non deve essere smaltito tramite la procedura normale di smaltimento dei rifiuti domestici. Per evitare eventuali danni all'ambiente e alla salute umana separare questo prodotto da altri rifiuti domestici in modo che possa venire riciclato in base alle procedure di rispetto ambientale. Per maggiori dettagli sui centri di raccolta disponibili, contattare l'ufficio governativo locale o il rivenditore del prodotto.
- D** Richtlinie 2002/96/EU (Elektro- und Elektronik- Altgeräte - WEEE):  
Benutzerinformationen  
Der Aufkleber mit durchgekrenzter Mülltonne an diesem Produkt weist darauf hin, dass dieses Produkt nicht im normalen Hausmüll entsorgt werden darf. Zur Vermeidung einer möglichen Beeinträchtigung der Umwelt oder der menschlichen Gesundheit darf dieses Produkt nicht in den Hausmüll gegeben werden, um zu gewährleisten, dass es in einer umweltverträglichen Weise recycelt wird. Wenden Sie sich für Informationen zu Entsorgungseinrichtungen an die zuständige Behörde oder das Geschäft, in dem Sie dieses Produkt erworben haben.
- F** Directive 2002/96/CE (Déchets d'équipements électriques et électroniques - DEEE):  
informations aux utilisateurs  
L'étiquette apposée sur ce produit et représentant une poubelle à roulettes rayée indique que le produit ne peut être mis au rebut avec les déchets domestiques normaux. Afin d'éviter d'éventuels dommages au niveau de l'environnement ou de la vie humaine, veuillez séparer ce produit des autres déchets de manière à garantir qu'il soit recyclé de manière sûre au niveau environnemental. Pour plus de détails sur les sites de collecte existants, veuillez contacter l'administration locale ou le détaillant auprès duquel vous avez acheté ce produit.
- E** Directiva 2002/96/CE (Residuos de aparatos eléctricos y electrónicos - RAEE):  
Información para el usuario  
La etiqueta de un contenedor tachado que hallará en su producto indica que este producto no se puede tirar con la basura doméstica normal. Para impedir posibles daños medioambientales o para la salud, separe este producto de otros canales de desecho para garantizar que se recicle de una forma segura para el medio ambiente.  
Para más información sobre las instalaciones de recolección disponibles, diríjase a las autoridades locales o al punto de venta donde adquirió este producto
- SE** Directive 2002/96/CE (Waste Electrical and Electronic Equipment - WEEE) information for users  
  
Symbolen med en överkorsad soptunnan innebär att denna produkt inte får kastas i vanligt hushållsavfall. För att skydda miljön och hälsan bör denna produkt inte kastas tillsammans med vanligt hushållsavfall utan lämnas för återvinning på tillbörligt sätt. Örmerinformation om uppsamlingsplatser, kontakta en lokal myndighet eller den återförsäljare som du köpte produkten från.
- NL** Richtlijn 2002/96/EG (Afgedankte Elektrische en Elektronische Apparaten - AEEA):  
  
informatie voor de gebruikers  
Op uw product is een label van een rolcontainer met een kruis erdoor aangebracht. Dit wil zeggen dat dit product niet bij het normale huishoudelijk afval mag worden gedaan. Om eventuele schade aan het milieu of de gezondheid van de mens te voorkomen moet dit product gescheiden van al het ander afval worden ingezameld, zodat het op een verantwoorde wijze kan worden verwerkt. Voor meer informatie over uw lokale afvalinzameling wendt u zich tot uw gemeente of de leverancier bij wie u dit product hebt gekocht.



This information only applies to customers in the European Union, according to Directive 2002/96/EC OF THE EUROPEAN PARLIAMENT AND OF THE COUNCIL OF 27 January 2003 on waste electrical and electronic equipment (WEEE) and legislation transposing and implementing it into the various national legal systems.