

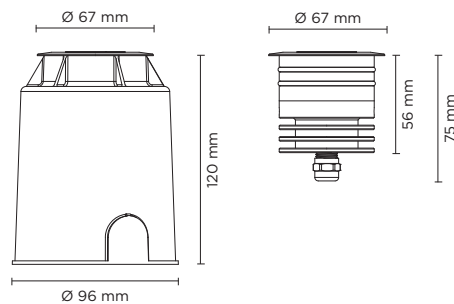

201072

## HYDROFLOOR NANO XS

Round ground-recessed luminaire for outdoor installation, Hard anodized black aluminium body and stainless steel AISI 316 front trim, tempered safety glass, moulded silicone gasket. Remote constant current max 700 mA driver needed, with 1 CREE XP-L LED. IP68 rating.



### 350 mA - LED POWER 1.2W

light source	light beam options	lumen output (lm)	lumin. efficacy (lm/w)
<b>3000°K warm-white</b>			
high-power led	10°	138	115.00
high-power led	30°	132	110.00
high-power led	45°	125	104.00
<b>4000°K neutral-white</b>			
high-power led	10°	144	120.00
high-power led	30°	137	114.00
high-power led	45°	131	109.00

**2700°K CCT** available on request

#### Finish color options:

Stainless Steel

#### Technical features









#### Technical data







Wattage	Max 2,5 WATT
IP Rating	IP68
IK Rating	IK09
Material	Hard anodized black aluminium body
Trim	Stainless steel AISI 316 L
Light source	NR. 1 x CREE XP-L LED
Remote driver	Constant current max 700 mA
Static weight resistance	Max 3000 Kg
Gasket	Silicone rubber
Glass	Tempered
Cable gland	M12
Power cable	1 mt. neoprene power cable included
Gross weight	0,70 Kg



**500 mA - LED POWER 1.7W**

light source	light beam options	lumen output (lm)	lumin. efficacy (lm/w)
<b>3000°K warm-white</b>			
high-power led	 10°	196	115.00
high-power led	 30°	187	110.00
high-power led	 45°	177	104.00
<b>4000°K neutral-white</b>			
high-power led	 10°	204	120.00
high-power led	 30°	194	114.00
high-power led	 45°	186	109.00
<b>2700°K CCT</b> available on request			

**700 mA - LED POWER 2.5W**

light source	light beam options	lumen output (lm)	lumin. efficacy (lm/w)
<b>3000°K warm-white</b>			
high-power led	 10°	288	115.00
high-power led	 30°	275	110.00
high-power led	 45°	260	104.00
<b>4000°K neutral-white</b>			
high-power led	 10°	300	120.00
high-power led	 30°	285	114.00
high-power led	 45°	273	109.00
<b>2700°K CCT</b> available on request			



**OPTIONAL**

AC063  
HONEYCOMB LOUVER

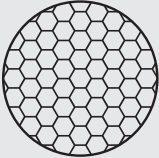

**AC055 STANDARD GLARE SHIELD**

Glare shield accessory made in hard anodized black aluminum, providing good balance in between glare control and light output.



**AC056 SUPER COMFORT GLARE SHIELD**

Glare shield accessory made in hard anodized black aluminum, for applications requiring very reduced glaring; minimal light loss on the light surface but overall lumen output typically reduced by 50%.



**remote driver selection**

brand	manufacturer code	type	watt	IP rate	numbers of fixtures
ALVIT Italy	AL1435S-IP	constant current 350mA	14W	IP67	min 1 - max 8
ALVIT Italy	AL1450S-IP	constant current 500mA	14W	IP67	min 1 - max 6
ALVIT Italy	AL1470S-IP	constant current 700mA	14W	IP67	min 1 - max 4