

HYDROFLOOR MAXI INVISIBLE LED

COD 206003

ASSEMBLY AND OPERATING INSTRUCTIONS:



-Class I fitting electric grounding is needed

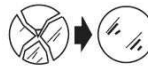

- replace the damaged protective glass
- sostituire i vetri di protezione se danneggiati
- die Beschädigten Schutzgläser ersetzen
- remplacer les verres de protection abîmés
- glass features: plane float glass - safety tempered
- caratteristiche vetro: vetro piano float di sicurezza temperato
- Glaseigenschaften: Float-Flachglas, gehärtetes Sicherheitsglas
- caractéristiques du verre: type de verre: plan "float" de sûreté trempé



-getting rid of as urban waste forbidden
-separate collection is mandatory when the product is at the end of its life



Made in Italy IP67

COD. 206003

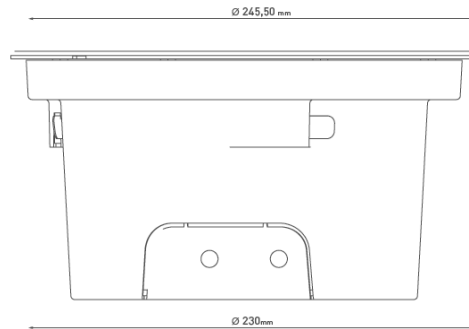

HYDROFLOOR MAXI INVISIBLE LED

- Power consumption : 27W
- Voltage : 220-240V 50-60Hz
- Color Temperature : 3000K - 4000K
- Beam angle : 18-36°
- Insulation class: I
- IP protection: IP67
- Gross weight: 4.5kg

NB: These assembly instructions must be given to end users for correct maintenance and so that they know how to change the bulb. The appliance must not be tampered with or transformed and it must be installed and used as supplied and in compliance with the National Rules on Installations. Any non-compliant installations will invalidate all forms of guarantee. The company cannot be held



- GB Retain the instructions.
- I Conservare le istruzioni.
- D Retain the instructions.
- F Bewahren Sie die Anleitung.
- E Conservez ces instructions.



Walk over fittings max static weight 5000kg

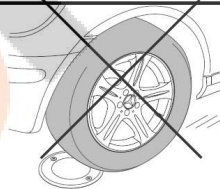

Do not use water high pressure cleaners

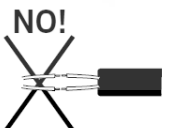

Use only supply cables with double case

HYDROFLOOR MAXI INVISIBLE LED

The luminaire is supplied by us with LED illuminator already installed with built in SELV power supply.

The cable and the fixture must not be tampered with for any reason.

It is essential to do a frequent cleaning of the glass and of the outer surface of the fixture to avoid build up of mud and dirtiness resulting in dangerous overheating due to uncorrect light and heat dissipation. Clean carefully the glass screen removing limestone deposits by means of a scraper.

The replacement must be done by a qualified electrician.

Recommendations

- 1) verify that the equipment used to connect our devices to enjoy all the guarantees required under European law;
- 2) use the cables, connectors and quality materials for electrical wiring;
- 3) Products with IP65/68 degree make the wiring / connections with accessories provide the same degree IP of the selected product (available in the catalog);
- 4) In the case of installations outside is not recommended to install the power supplies in the formwork and / or in the junction box without adequate protection

Choice of installation location

The unit should be positioned so that when in use is not subject to direct radiation from the sun or other heat sources . High temperatures reduce the life and efficiency of the components or the LED module .

Note on corrosion protection

- Install recessed in the ground so that water can flow away from the surface of the device. Both for the recessed directly in the ground , both for the use of a recessed housing , it is necessary to perform a further drainage , for example , using a bed of gravel.- For installation and maintenance must be especially careful not to damage the coating powder . Damage combined action of water could cause corrosion. Recommend mounting the device to the floor with a pH value between 5 and 8. In ambient environment the assembly and maintenance of all components require the appropriate security measures . The chemicals damage the corrosion protection

INSTALLATION:

-SWITCH-OFF THE POWER SUPPLY BEFORE CARRYING OUT ANY MAINTENANCE OPERATIONS

1. Prepare the bed with gravel sand and drainage bed (pic1)
2. If it is necessary, make the beam regulation with open the luminaire by unscrewing the bottom screws remove the ring, the glass and than making the orientation (max + - 15°) (pic 2) .
3. Insert the cable through the feeding point and making the correct electrical connection
4. Place the luminaire into the recessing box , making the twist and lock

Pic 1

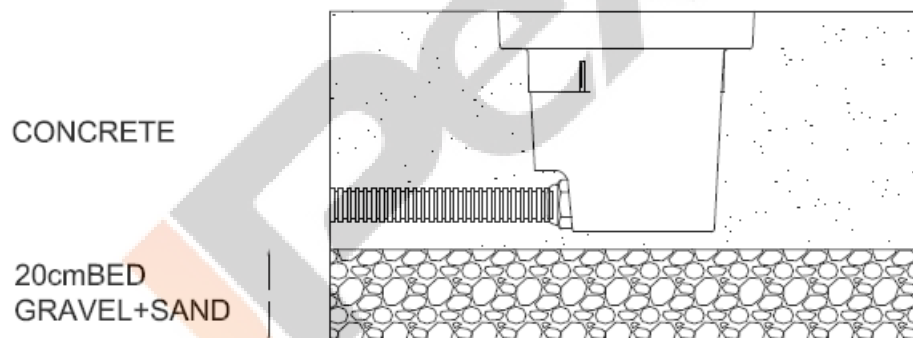

Pic 2

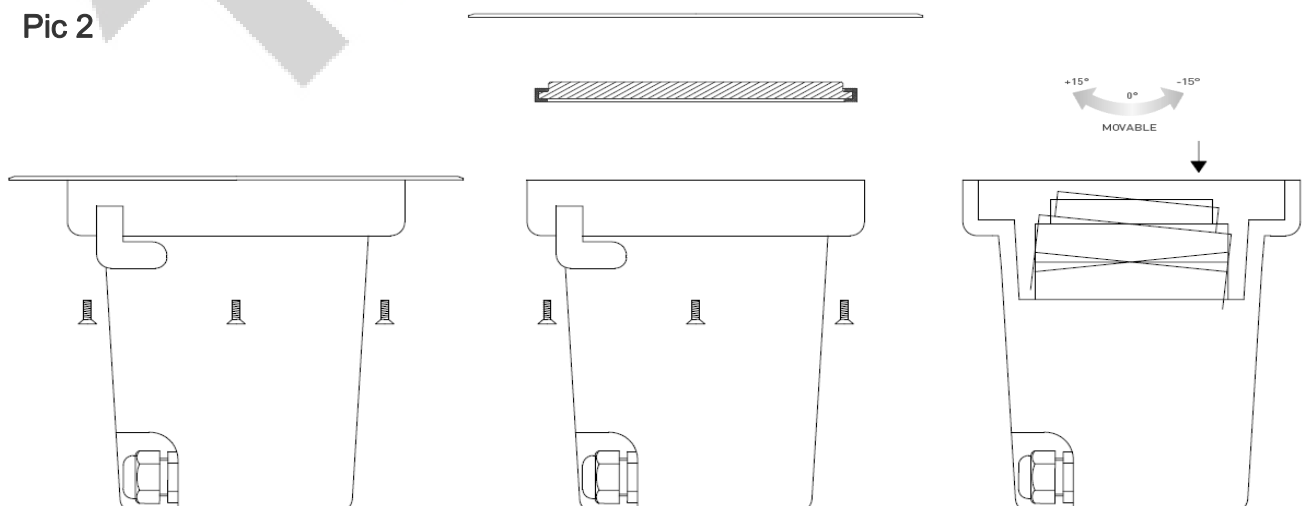

Pic 3

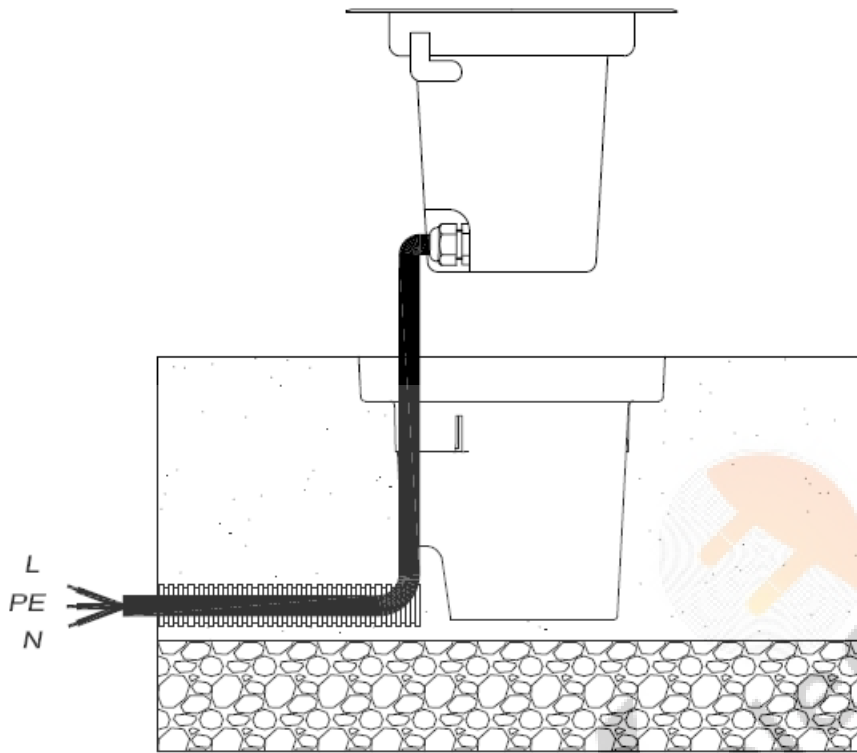

Pic 4

